



## Schindler 6300

When ready-to-go is made to measure.  
The smart replacement elevator for a  
wide range of applications.

**According to EN 81 20/50**

New European standards



# The key benefits at a glance.

## ▶ Out-of-the-box usability

A combination of pre-engineered components and flexibility right where it is needed. This replacement offers a ready-to-go solution that lets you get the modernization done easily.

## ▶ Comfort & space

The Schindler 6300 is made-to-measure to maximize your shaft space usage. A compact drive enables a larger car as well as car and door dimensions which are gradually adjustable to suit your needs.

## ▶ Green mobility

The perfect interplay of components with the latest technology ensures true energy efficiency and minimal environment impact. This makes the Schindler 6300 a highly economical system.

## ▶ Delightful design

This elevator supports the characteristics of your building by offering four decor lines and 41 different colours. Our pre-selected decor lines are completed with the Libertà line – giving you full freedom of choice.

### Key Specifications

Capacity	320 to 1,125 kg, 3 to 15 passengers
Travel height	max. 75 m, max. 20 stops
Entrances	one-sided, two-sided
Car width	760 to 1,600 mm (10 mm increments)
Car depth	900 to 2,100 mm (10 mm increments)
Door systems	telescopic doors (T2), centered doors (C2, C4)
Door frames	use existing frames or new frames or complete metal shaft front
Door width	600 to 1,100 mm (50 mm increments)
Door height	2,000 to 2,300 mm (100 mm increments)
Car height	2,039 to 2,439 mm (100 mm increments)
Drive	eco-friendly gearless drive system
Speed	1.00 m/s (320-1,125 kg), 1.6 m/s (535-1,125 kg)
Control	push-button control: pick-up collective, down collective and selective collective
Interior	two style sets and four décor lines or Libertà concept

# Out-of-the-box usability

Refresh your building the smart way. The Schindler 6300 modernization elevator easily lets you get the job done.

## Fast planning

Thanks to the well-thought-out replacement concept of the Schindler 6300, you'll benefit from a genuine ready-to-go solution that offers exactly what really matters for residential or small commercial buildings: the advantage of pre-engineered components you can virtually use "out-of-the-box" plus the comfort of deliberate flexibility of the car right where you need it – fast planning is our word. By the way do not forget the cost-effectiveness that comes in hand with the pre-engineered components.



## Fast installation

Do you hate waiting? So do we. That's why we have worked hard to minimize building adaptations and optimize the installation process when replacing your elevator, setting new standards in the field. In fact, installation of the Schindler 6300 requires up to 40% less time than a conventional replacement. Residents can therefore look forward to minimum disturbances and the least possible downtime, while you enjoy a fast installation process.



## Improved safety

The Schindler 6300 ensures improved safety for customers, visitors and residents. It meets the latest EU safety requirements and is EC type certified according to latest regulations and a (New Lifts Directive 2014/33/EU, European lifts standards EN 81-20/50, European standard EN 81-21 for new lifts in existing buildings, and optionally European standard EN 81-70 regarding accessibility to lifts for persons with disabilities) – all in one step.



## Focused on quality

Installing the Schindler 6300 will significantly increase the value of your building. You will enjoy the benefits of a pre-engineered elevator system, constructed with precise processes and high quality components. So you know you're getting the best possible replacement package on the market. Plus: you'll benefit from the global expertise of a market leader with an unparalleled commitment to continuously optimizing the quality of its products and services.



## Superior standards

### Flexibility

Car can be adjusted to existing shafts in 10mm steps. Car door can be adjusted in 1mm steps to the shaft door. We make the best out of the available space.

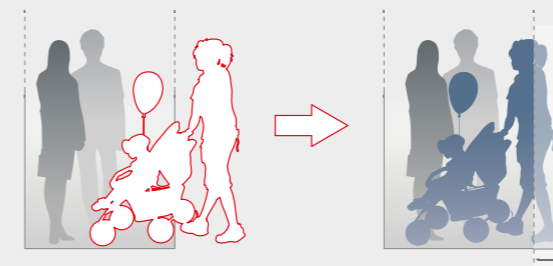

### Green mobility

Schindler commits itself to a sustainable future – no question that clean drive technology, LED lighting and standby mode are standard features.



# Comfort and space

Space is limited, especially when replacing an elevator. Existing dimensions of shafts and doors, limited room for installations – all this can make replacements a difficult task. With the Schindler 6300 you don't need to worry. We made sure it is built to fit.

## Developed for a perfect fit

The Schindler 6300 uses the available space accurately, down to the last millimeter. The car can be adjusted to the dimensions of very small shafts in 10 mm increments. The car door position can even be displaced in 1 mm increments; far more than might be normally expected

from a ready-to-go solution. Thanks to other space-saving features, such as standard machine-room-less technology and the reuse of existing door frames, the Schindler 6300 will fit the structural conditions of your building with ease.

## Innovative traction media: highest comfort

### Conventional technology

Steel cables used in conventional technology are relatively inelastic. They need a traction sheave diameter of at least 320 mm with the cable diameters required for elevators. The complete conventional motor including drive gears must be large and powerful enough to match a system that requires space while creating noise and vibration.

### Schindler 6300

Traction media used for the Schindler 6300 are flexible. They use a much smaller traction shaft diameter than steel cables. 85 mm is enough, requiring less space and power. A design that saves space and significantly reduces noise and vibration – providing you the highest comfort possible.

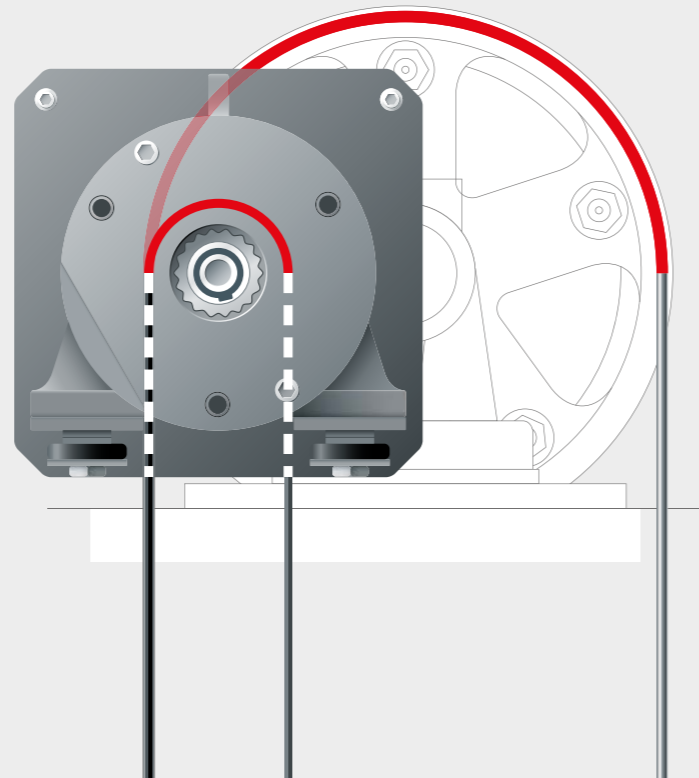

## More space in small shafts.

### Limited space. Flexible car.

The Schindler 6300 concept ensures more space in the car – even in small shafts. The car can be adapted to the shaft dimensions in 10 mm increments. The car width ranges from 760 mm to 1600 mm, the car depth from 900 mm to 2,100 mm. This flexibility combined with optimized guiding and high quality shaft components ensures that the Schindler 6300 is the best solution for the needs of any building.

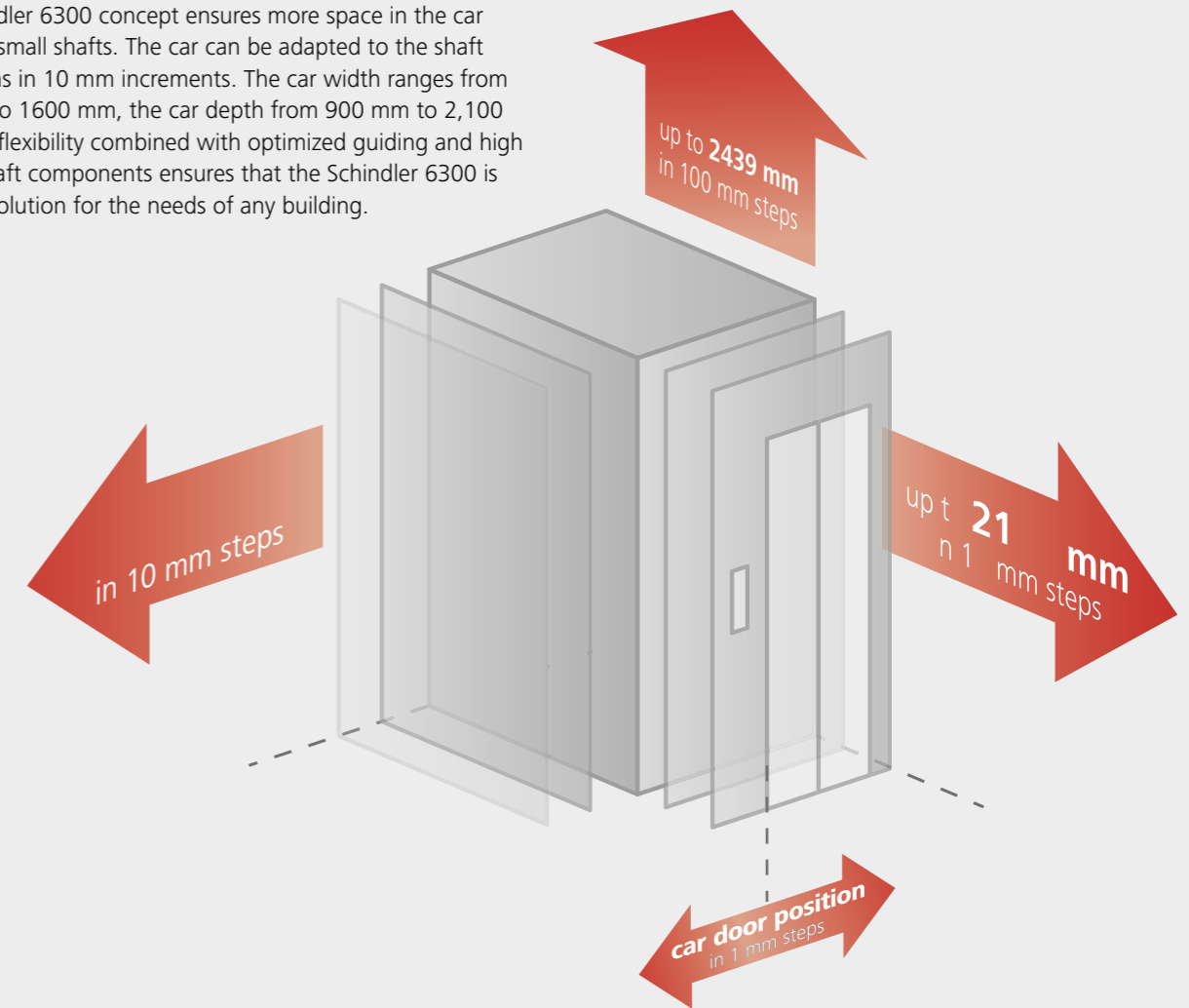

## The door system: flexible in every respect

### Flexible position, flexible width, flexible layout

Thanks to a highly flexible door system, the position is flexible in 1 mm increments and the door width can be planned in 50 mm increments with a door height of 2,000 or 2,100 mm. Existing frames can be reused, new frames or even complete metal shaft fronts can be delivered. The installation in niches creates more space for the car. Different door layouts such as telescopic (T2) and centered doors (C2, C4) are available. The system allows a one or two-sided entrance.

### Choice of doors

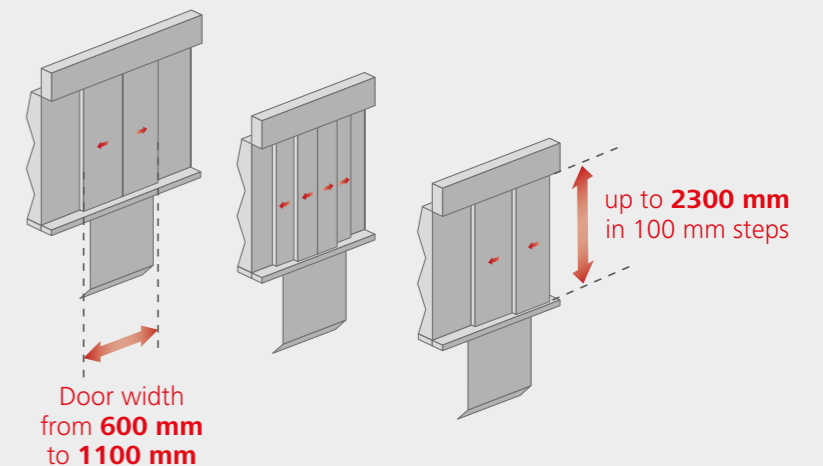

# Green mobility

Caring for tomorrow starts today. The Schindler 6300 is a lightweight elevator free from harmful substances and designed for low everyday energy consumption. The operating efficiency remains steady over the course of its lifetime – and this elevator is almost 100% recyclable.

up to  
**-30%**  
of energy consumption



### Clean drive technology

Thanks to the optional regenerative Power Factor One drive technology, the Schindler 6300 uses up to 30% less travel energy compared to conventional technologies. Excessive energy is “clean”, allowing it to be fed back to the grid without causing equipment interference due to harmonic distortion.

**20x**  
longer than  
standard bulbs

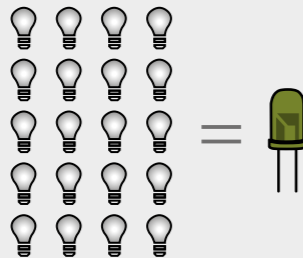

### LED lighting

LED lights have an extremely long service life, up to 20 times longer than standard light bulbs, while consuming less energy. All ceilings in the Schindler 6300 are equipped with LED lights as standard.

**-40%**  
energy consumption  
in standby mode



### Standby mode

When not in use, the Schindler 6300 consumes up to 40% less energy for inverter, controls, lights and ventilation. Wake up is instantaneous.

### Energy efficient operation

Superior everyday performance should not be synonymous with higher energy consumption – and with the Schindler 6300 it is not. Thanks to its lightweight system, precision engineering and energy saving features, the Schindler 6300 achieved A classification for energy efficiency according to the VDI4707-1 standard.

\* The VDI 4707-1 standard regarding the energy efficiency of lifts is established by the Association of German Engineers (VDI). The VDI 4707-1 standard classes range from “A” to “G”, with class “A” being the most energy efficient class. The given result is based on measurements and valid for a Schindler 6300 in VDI usage category 1 with a load of 400 kg, a travel height of 13 m, a speed of 1,0 m/s and with additionally selectable energy-saving features (e.g. Recuperating Frequency Converter (PF1)). The VDI classification and energy consumption of individual installations may deviate from this result, e.g. due to different or additional customer options and/or different configuration.



## More brainpower. Less environmental impact.

Schindler strives to contribute to sustainable and energy efficient buildings. The Schindler 6300 passenger elevator is a fully pre-engineered product in which all parts are perfectly adjusted. Over the last decade, Schindler has improved the eco-performance of its products by more than 50%. Ecologically responsible production and material usage, convenient planning, fast installation and trouble-free maintenance make the system perfect.

### Saving energy with innovative drive technology

- Gearless machine for smooth ride quality
- Efficient motor enabling a direct power transfer, avoiding loss of power
- Stable start without high peak current, quickly reaching a low energy consumption level
- Frequency converter equipped with stand-by power mode and optional braking energy regeneration
- Environmentally friendly as no oil is needed for lubrication
- Compact, lightweight and durable design that optimizes material usage and extends the product’s lifespan

### Controlling the efficiency

- Car lights and ventilation are switched into stand-by mode when not in use
- Car panel and floor indicators operate with low power LEDs
- Multi-bus control architecture reduces cabling, material and waste
- Down collective and selective collective controls for efficient passenger transportation
- Optional: highly efficient Schindler PORT technology

### Optimizing car and shaft usage

- Efficient design maximizes car space compared to shaft dimensions
- Numerous technological innovations to optimize efficiency
- Car lighting equipped with energy-saving LED lamps
- Central guiding system reduces mechanical friction and energy consumption
- Door drive features stand-by mode for safety and energy conservation
- Full range of standard applications with lead-free counterweight

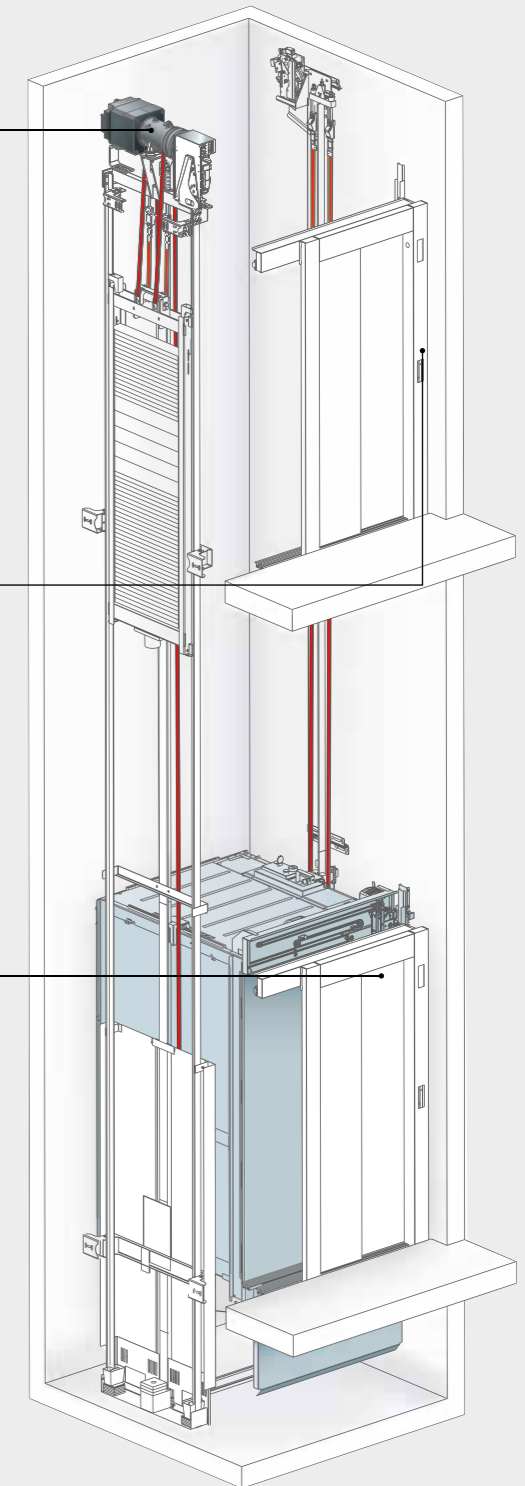

# Delightful design

Create the look and feel you want. Combine colours, materials, lighting, mirrors, handrails and fixtures to achieve the ambiance that fits both your ideas and your building. Choose from one of our four interior design lines or create the car to your own taste.

## Add personality to your elevator

«Saint Tropez», «Laffitte», «San Marco» and «Park Lane» – our four design lines offer a wide range of decoration options. Choose your design to match your architectural concept and ideas. Provide a unique ride experience with fresh colour, distinctive patterns and high-quality materials.

For detailed information on our four design lines see our separate design lines brochure.



## Libertà concept

If you can't find the style you're looking for in our pre-selected range of interior lines, then you can design your car according to your own taste.

## Saint Tropez

Saint Tropez offers a variety of upbeat and visually striking colours, from bright and breezy to warm and welcoming. Choose one colour for the entire car interior or vary the colour of the rear wall for contrast – an option exclusive to this line.

## Laffitte

Perfect for professional settings, this line's autumnal Northern hues express everyday sophistication. The colour laminates create a glossy effect and lend the car a distinguished feel.

## San Marco

The San Marco line's naturalistic wood laminate evokes harmony and modernism. Four different styles are at your disposal. Select wood structures, colours, and finishes to create a warm atmosphere in your elevator.

## Park Lane

Captivating stainless steel sets the Park Lane line apart. Six different types of stainless steel are available, from bright brushed to gold, with patterns or without. All are discreetly modern and unassuming.

## Libertà

If you can't find the style you're looking for in our pre-selected range of interior lines, then you can design your car according to your own taste. And you can take advantage of an enhanced allowance for special cladding weighing up to 300 kg and car floor material up to 40 mm thick.

## Saint Tropez



## Laffitte



## San Marco



## Park Lane



## Note

Specifications, options and colours are subject to change. All cars and options illustrated in this brochure are representative only. The samples shown may vary from the original in colour and material.

# The perfect outfit with matching accessories

## Operating panels and options

### Outfit your elevator with style

Our operating panels and options, such as handrails, mirrors and lighting, suit your chosen decor to give your elevator the perfect finish – down to the smallest detail.

### Mirrors

Mirrors always add a special sense of space to rooms and buildings. In order to give your car more appeal and depth, one sidewall or the rear wall can be provided with a half or full-height safety glass mirror.

### Handrails

Even though your elevator travels smoothly, handrails convey a feeling of security. Round or straight handrails match the interior and shapes of your car and can be mounted to the side and rear walls.

### Lighting

A selection of different lighting options lets you add the right atmosphere to your elevator – choose between a round and a square style set.

### Operating panels

Make your elevator easy to operate for all passengers. Energy-efficient operating panels all come in high-quality materials and finishing. And to add further elegance to your car interior, you have the option of full-glass fixtures or a full-height car operating panel.

Easy-to-read indicators and signs make for a safe and pleasant ride.

For a complete overview of all fixtures and options, see our separate decor lines brochure.



## Stainless steel panel line

Our sleek and wear-resistant combination of stainless steel and glass is equipped with mechanical push buttons. The line consists of car operating panels and landing operating panels as default elements. For clear navigation throughout your building, indicators and nameplates can be supplied.

### Keypad

The keypad features a conventional layout. Each floor is listed separately, ideal for low-rise buildings. Buttons will be arranged in single, double or triple columns, depending on the number of floors.



## Glass panel line

Our stylish and modern glass panel line is equipped with a touch-sensitive keypad. The line consists of car operating panels and landing operating panels as default elements. For clear navigation throughout your building, indicators and nameplates can be supplied.

### Keypads

The glass panel line features two keypad versions for car operating panels. A ten digits layout, allowing passengers to compose the desired floor number (like a phone); and a conventional layout listing each floor (best suited for low rise buildings). Buttons are arranged in triple columns.



Surface mount  
For classic designs



Flush mount  
For a modern, minimalistic look



Corners  
2 Finishings

Corner  
Aluminum Polished

Skirtings  
2 Finishings

Skirting  
Aluminum Anodized

Floors  
8 Colours

Floor  
Artificial granite Black

Walls  
33 Colours

Wall  
Laminate Cadiz Blue

Rear Wall  
Glass

Rear Wall  
Brushed steel  
Doha Gold

Car Door &  
Front  
3 Finishings

Car door & front  
Lausanne Linen

Lighting  
5 Styles

Lighting  
Spot

Handrails  
3 Shapes  
3 Finishings

Handrail straight  
Stainless steel Brushed

Ceilings  
2 Finishings

Ceiling  
Stainless steel Lugano  
Matt



Glass doors



Glass rear wall



# Libertà – personalize your elevator

Would you like to have different coloured walls or a combination of different styles? With the Libertà concept you can enjoy the possibility to create your own car. Choose the ceiling, add any colour from our décor lines and select your options.

## Walls

Saint Tropez



Laffitte



San Marco

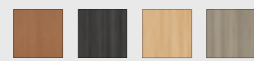

Park Lane

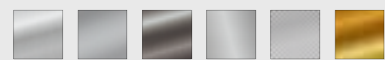

## Mirrors

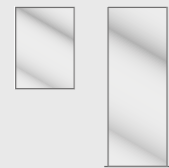

Placement

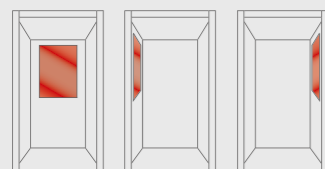

## Floor

Rubber speckled



Artificial granite



## Ceiling

Stainless steel Lugano Matt Finish

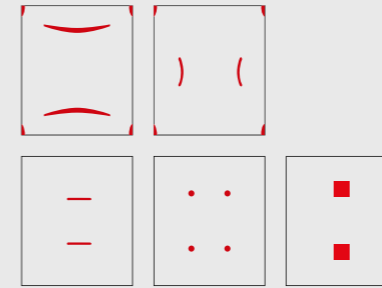

## Operating Panels

Stainless steel, push buttons

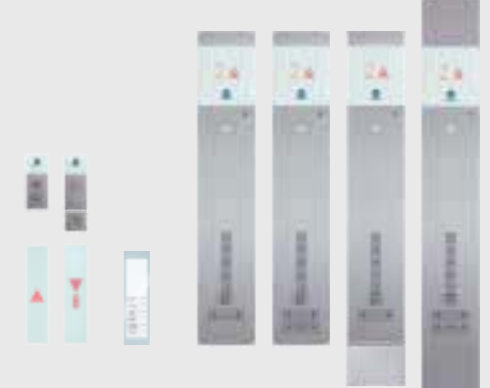

Glass, touch-sensitive

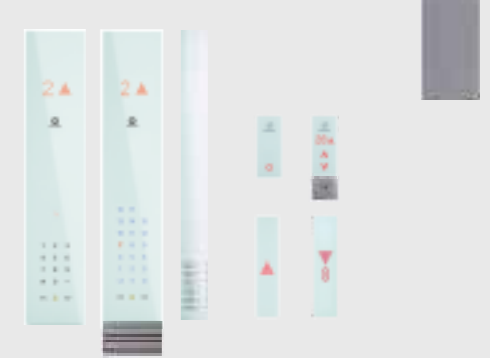

## Glass Rear Wall\*

Full or half height



## Handrails

Straight, straight with curved ends or curve & placement

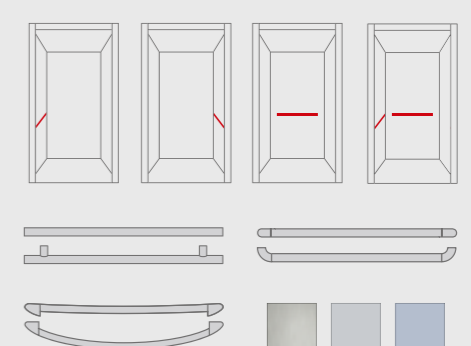

\* available for predefined car widths only

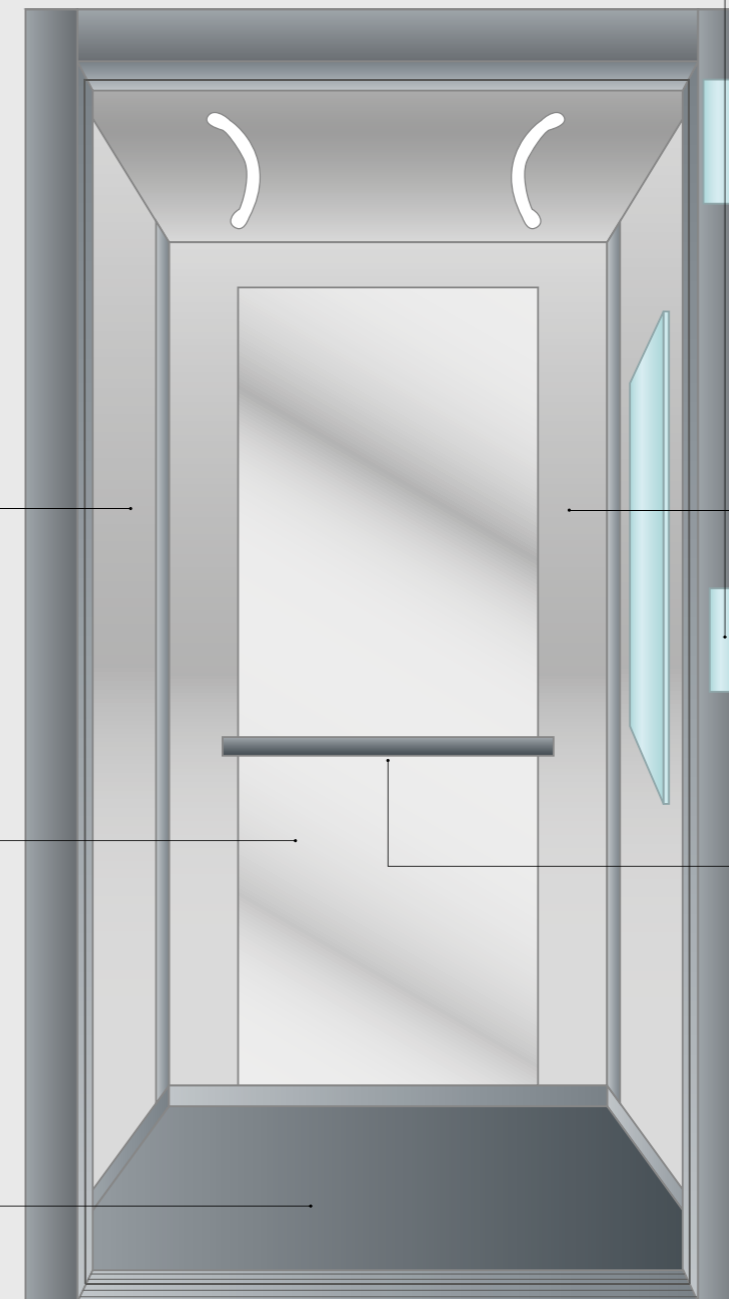

# From the subway to the skyline

## Providing urban mobility

Mobility is an essential requirement in the world in which we live and work. Schindler stands for urban mobility and is recognized as a hallmark of quality and safety. Daily, over one billion people worldwide place their trust in Schindler products and services.



### Trusted company

Dependability since 1874. Schindler provides urban mobility with elevators, escalators and services that are engineered for efficiency and sustainability. Our products are built to last and our expertise is based on:

- Swiss quality engineering
- More than 56'000 dedicated experts
- Network in over 100 countries, available 24/7

### Professional services

Dedicated experts that provide seamless support. Schindler is a reliable partner for the development of buildings from planning and construction to daily operation, thus safeguarding their lifetime value. We understand the challenges of different building types from airports to residential properties. We collaborate with you on:

- Planning & traffic calculations
- Maintenance, Repair & Modernization services
- Customer & Diagnostic services

### Smart solutions

Prepared for the future, made for purpose. Schindler technologies are engineered to optimally serve the requirements of users and buildings. We optimise transit management and service preventively with our maintenance methodologies.

- PORT transit management
- Schindler Direct monitoring & response service
- Schindler Dashboard online portal

# Built-to-last. Always up-to-date.



Modernizing ensures safety, comfort and protects your investment in the long term. Schindler replaces whole systems or step-by-step, by replacing specific parts. Schindler can upgrade any installation to meet passenger needs and to comply with official regulations. Find more information on Schindler products: just scan the code with your mobile phone, using free QR code scanner software. This is pre-installed on your phone or easily downloadable for free.



Schindler Management  
Group Sales & Marketing E1  
Zugerstrasse 13  
6030 Ebikon  
Switzerland

Phone: +41 41 445 31 31  
Fax: +41 41 445 39 11

[www.schindler.com](http://www.schindler.com)

**Schindler Your First Choice.**

This publication is for general informational purposes only and we reserve the right at any time to alter the product design and specifications. No statement contained in this publication shall be construed as a warranty or condition, expressed or implied, as to any product, its fitness for any particular purpose, merchantability, quality or shall be interpreted as a term or condition of any agreement regarding the products or services contained in this publication. Minor differences between printed and actual colours may exist.